

All products detailed in this section are not necessarily available in your state or country due to market requirements, or applicable standards and codes.

MOUNTING AND SUPPORTS

VIBRATION ISOLATION

ANTI-VIBRATION MOUNTS (AVM)

WAFFLE PAD

SPRING ISOLATION MOUNTS

METAL ANGLES

GENERAL INFORMATION

TOP HAT SECTIONS

GENERAL INFORMATION

HANGERS

THREADED ROD

PLAIN SHEETMETAL HANGING STRAP

PERFORATED SHEETMETAL HANGING STRAP

	J-AVM 1
	J-WP 1
	J-SM 1
	J-MA 1
	J-MA 1
	J-TH 1
	J-TH 1

J-ROD 1

	J-STRAP 1
	J-STRAP 2

TAPES AND SEALANTS

TAPES

FOIL JOINING TAPE

PVC JOINING TAPE

	J-FT 1
	J-DT 1

SUNDRIES ANTI VIBRATION MOUNTS (AVM)

AdvantageAir



FEATURES

- 5mm static deflection.
- Threaded top insert.
- Non skid rubber base.
- Colour coded load ranges.
- Corrosion resistant.

CONSTRUCTION

- Black filled natural rubber; UV and Ozone inhibited.
- Metal components are corrosion protected and embedded in the elastomer.

APPLICATIONS

- For mounting AACV range of outdoor units. See selection chart below.

	MOUNTING ENVIRONMENT			
	CEILING SPACE	FLOOR MOUNT	ROOF MOUNT	WALL MOUNT
ALL AACV FAN COIL UNIT	SPRING (ISOMOUNT)	N/A	N/A	N/A
AACV-147-CON1 (OUTDOOE UNIT)	N/A	WP (WAFFLE PAD)	AVM GREEN	AVM GREEN
AACV-164-CON3 (OUTDOOR UNIT)	N/A	WP (WAFFLE PAD)	AVM GREEN	AVM GREEN
AACV-200-CON3 (OUTDOOR UNIT)	N/A	WP (WAFFLE PAD)	AVM RED	AVM RED

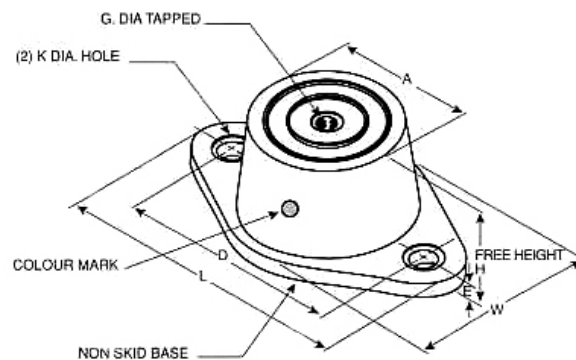

TYPE	COLOUR	MAX LOAD kg	DYNAMIC FACTOR	STATIC DE- FLECTION NR mm	HEIGHT NR mm	L mm	W mm	D mm	A mm	G mm	K mm	E mm
AVM RED	RED	40	1.2	5	28	80	45	60	36	M10	8.5	5
AVM GREEN	GREEN	55	1.3	5	28	80	45	60	36	M10	8.5	5

No liability

Make sure you read and understand all the installation instructions before you install this Anti-Vibration Mounts. Advantage Air (Aust) Pty Ltd does not accept any responsibility for any loss or damage that may be caused either directly or indirectly by the installation of this Anti-Vibration Mounts.

SUNDRIES WAFFLE PAD

AdvantageAir

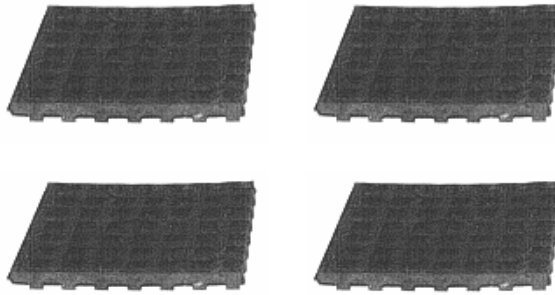

FEATURES

- Reduces unit elevation.
- Built in anti-contamination seal.
- Superior carrying capacity and grip.

CONSTRUCTION

- Neoprene.
- Resistant to oils.

APPLICATIONS

- Suitable for non-critical applications.
- Ideal for mounting ducted fan coil units and condensing units up to 6 HP.

DIMENSIONS

4 MOUNTS
SUPPLIED PER
PACK

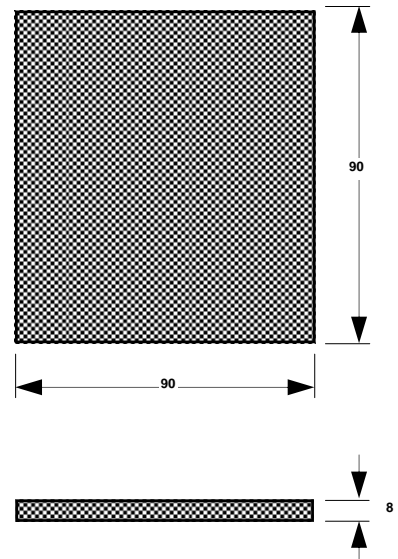

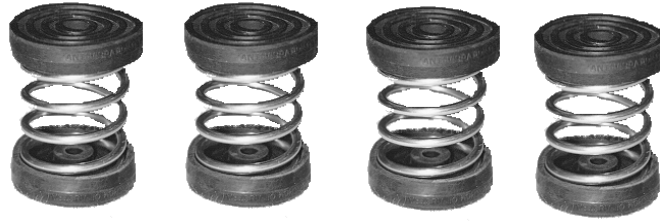

FEATURES

- Point loads up to 30 kg per mount.
- 25 mm static deflection.
- Superior acoustic properties.
- Sold in packs of four.

CONSTRUCTION

- Separate top and bottom locating cups of moulded neoprene with non-skid surfaces.
- Heavy duty stable steel spring.
- Colour code black.

APPLICATIONS

- Ideal for mounting ducted fan coil units up to 6 HP.

DIMENSIONS

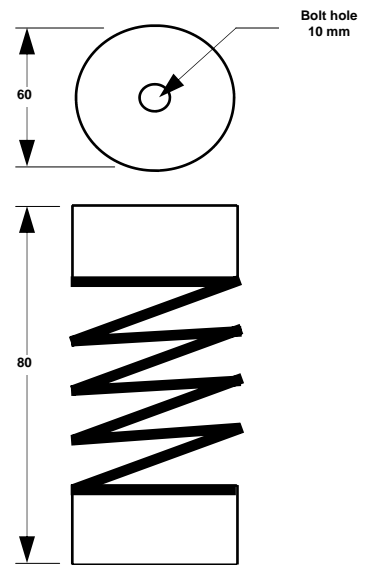

EVAP COOLER DROPPERS METAL ANGLES

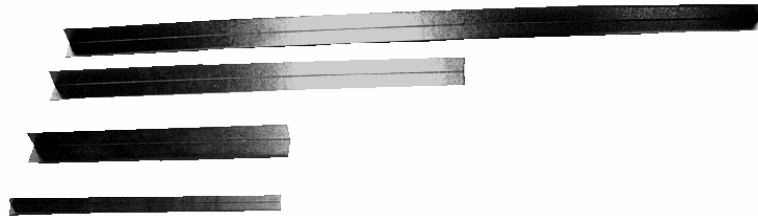

CONSTRUCTION

- Angles are constructed from galvanised sheet metal or primed mild steel depending upon the thickness of the angle.

APPLICATIONS

- Ideal for domestic evaporative cooler installations and for fixing grilles and diffusers

DIMENSIONS

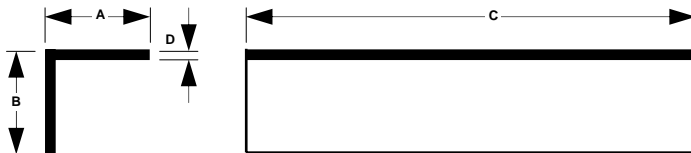

MODEL NO.	A mm	B mm	C mm	D mm
MA5006	50	50	600	1.6
MA5018	50	50	1800	2.0
MA5024	50	50	2400	2.0
MA2524	25	25	2400	0.4

Please note other sizes can be made to order and require 1 working days notice.

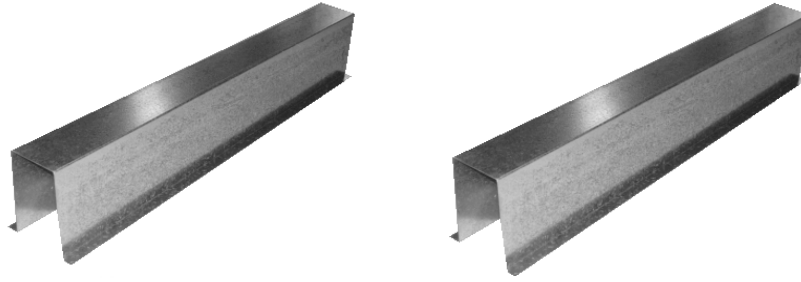

FEATURES

- Air conditioning unit supports to ensure the unit is installed level and slightly elevated.

APPLICATIONS

- Ideal for mounting condensing units and roof top package units.

CONSTRUCTION

- 1.6 mm bent up galvanised steel.

DIMENSIONS

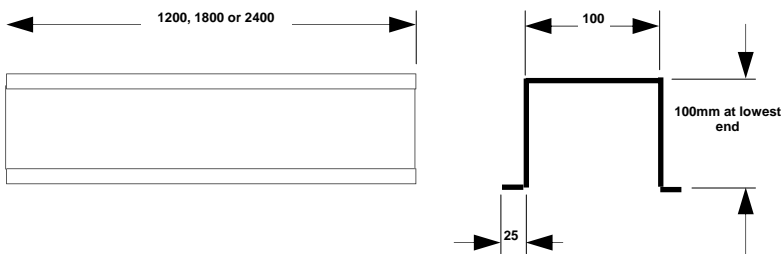

Other sizes are available on request

SUNDRIES THREADED ROD

AdvantageAir



CONSTRUCTION

- Zinc plated steel rod with full 10mm metric thread.
- Supplied in any length upto 3 metre lengths.

APPLICATIONS

- Ideal for hanging air conditioning equipment and sheetmetal ductwork.
- Nuts are an optional extra and must be specified at the time of ordering.

DIMENSIONS

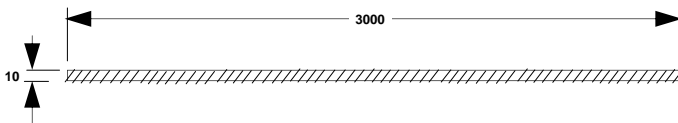

SUNDRIES

PLAIN SHEETMETAL HANGING STRAP

AdvantageAir

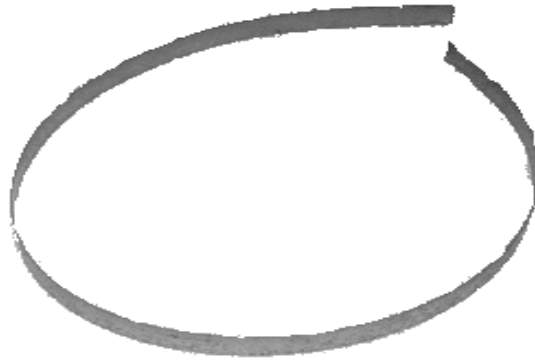

CONSTRUCTION

- Galvanised sheetmetal strips 0.55mm thick

APPLICATIONS

- Suitable for hanging air conditioning duct and equipment.

DIMENSIONS

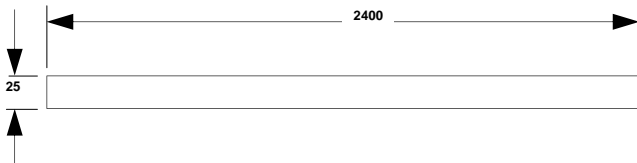

SUNDRIES PERFORATED SHEETMETAL HANGING STRAP

AdvantageAir



CONSTRUCTION

- Perforated sheetmetal hanging strap.
- Galvanised 0.55 mm thick.

APPLICATIONS

- Suitable for hanging fan coil units and other air conditioning components.

DIMENSIONS

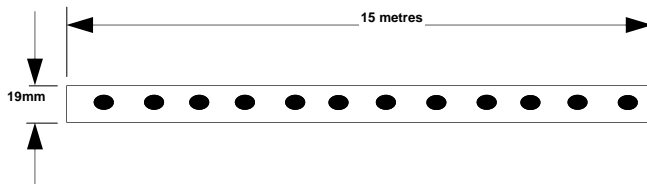

SUNDRIES FOIL JOINING TAPE

AdvantageAir

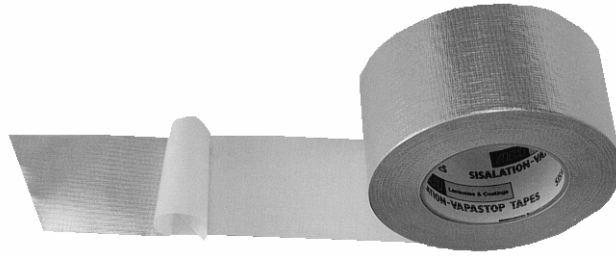

FEATURES

- ACI 883 Vapastop 72 mm wide x 50 metres long.
- Silver in colour.

APPLICATIONS

- Ideal for joining and sealing flexible duct, insulation and galvanised duct.

DIMENSIONS

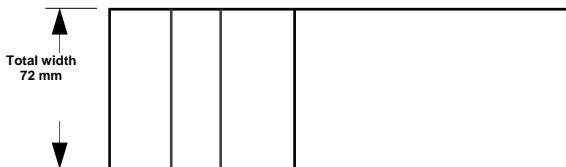
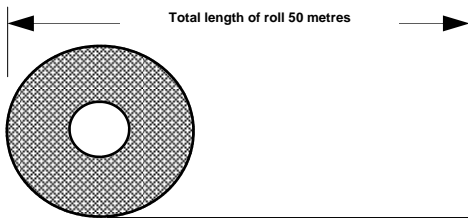

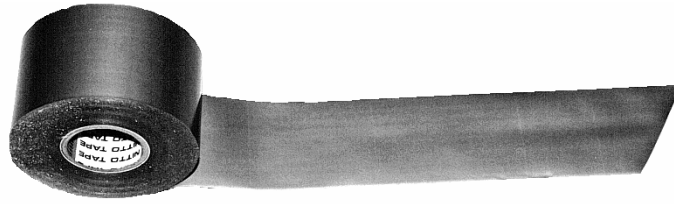

CONSTRUCTION

- Lower cost alternative to foil duct tape.
- 0.13 mm thick x 48 mm wide x 30 metres long.
- Grey in colour.

APPLICATIONS

- Ideal for joining and sealing flexible duct, insulation and galvanised duct.

DIMENSIONS

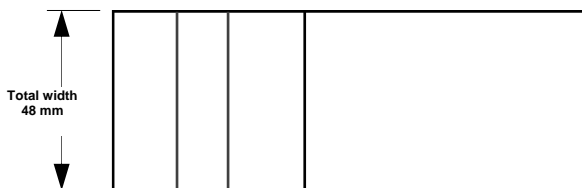
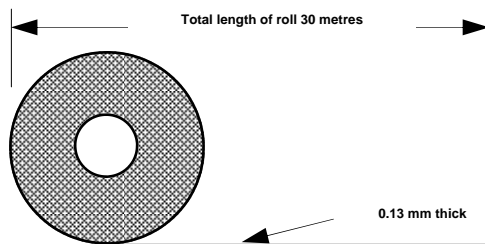

We recommend ordering one roll per outlet on a typical domestic evaporative, refrigerated or heating system.